

LCD-M4K492XDB
UNIT:mm
12-June-2019

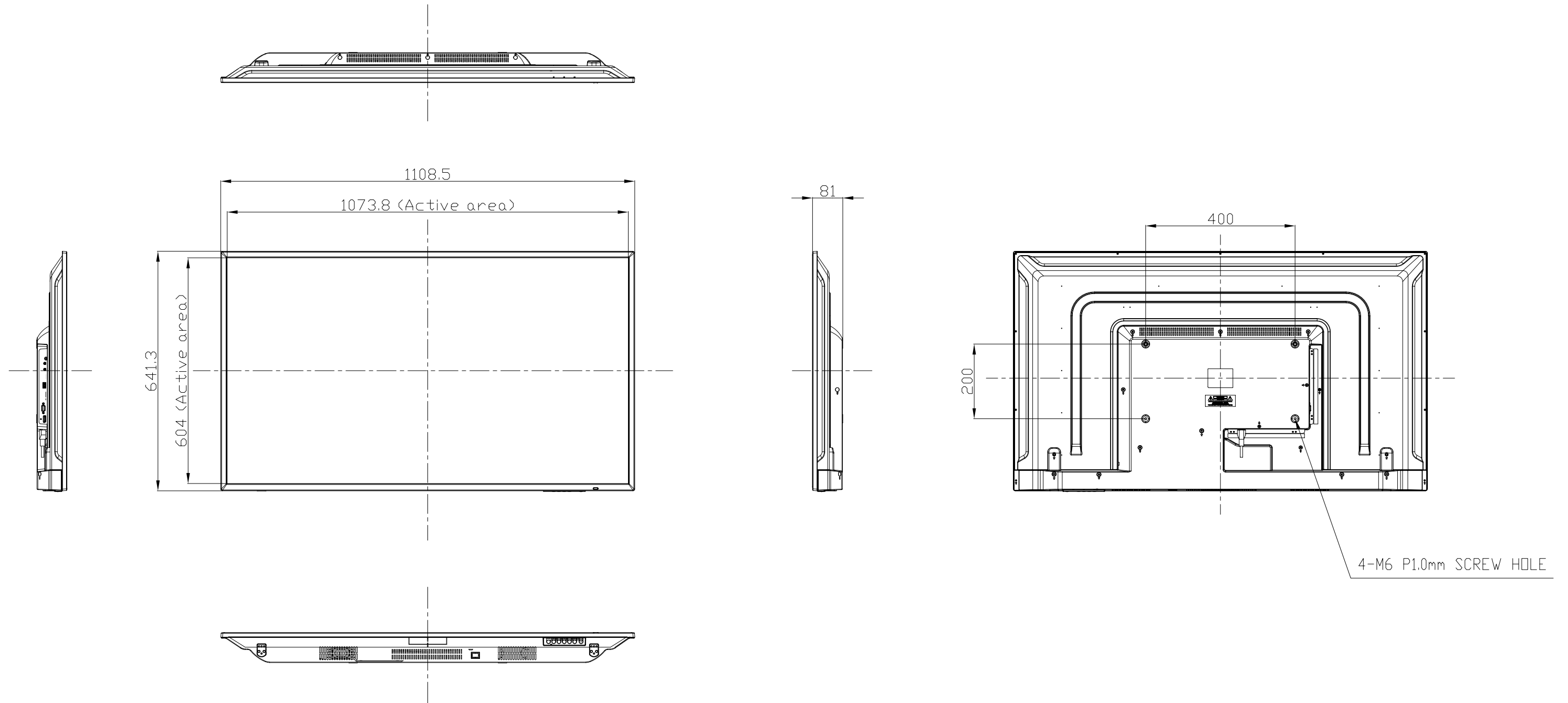

<Note>

- 1.)Dimensions tolerance is within $\pm 2.0\text{mm}$ unless otherwise specified.
- 2.)Relative to the center line, and symmetrically unless otherwise specified.
- 3.)This drawing is reference materials.
Therefore there is a possibility to change without notice.