

GD271JD Series  
UNIT:mm

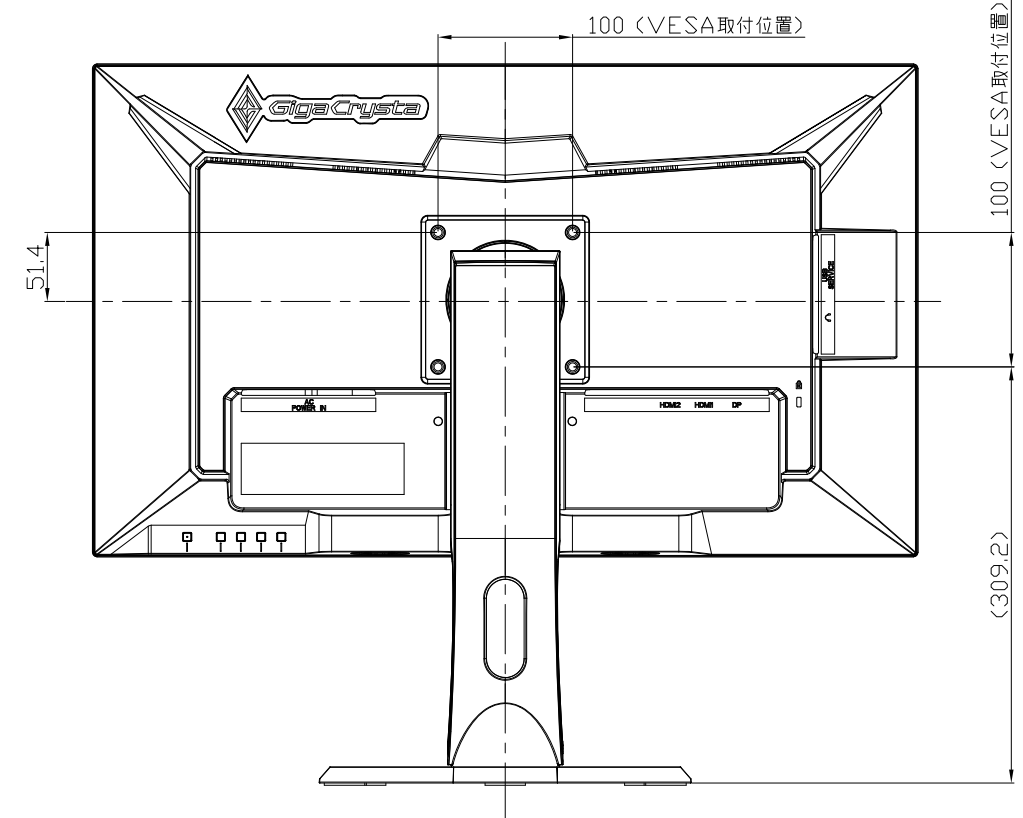
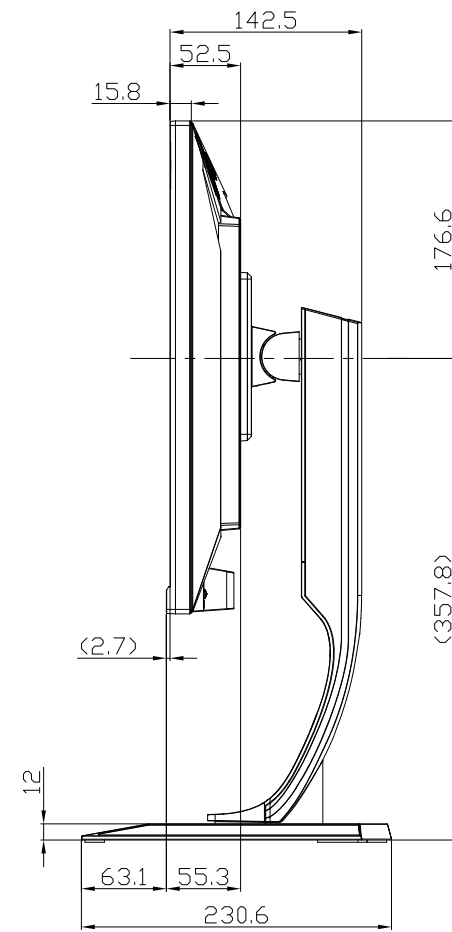
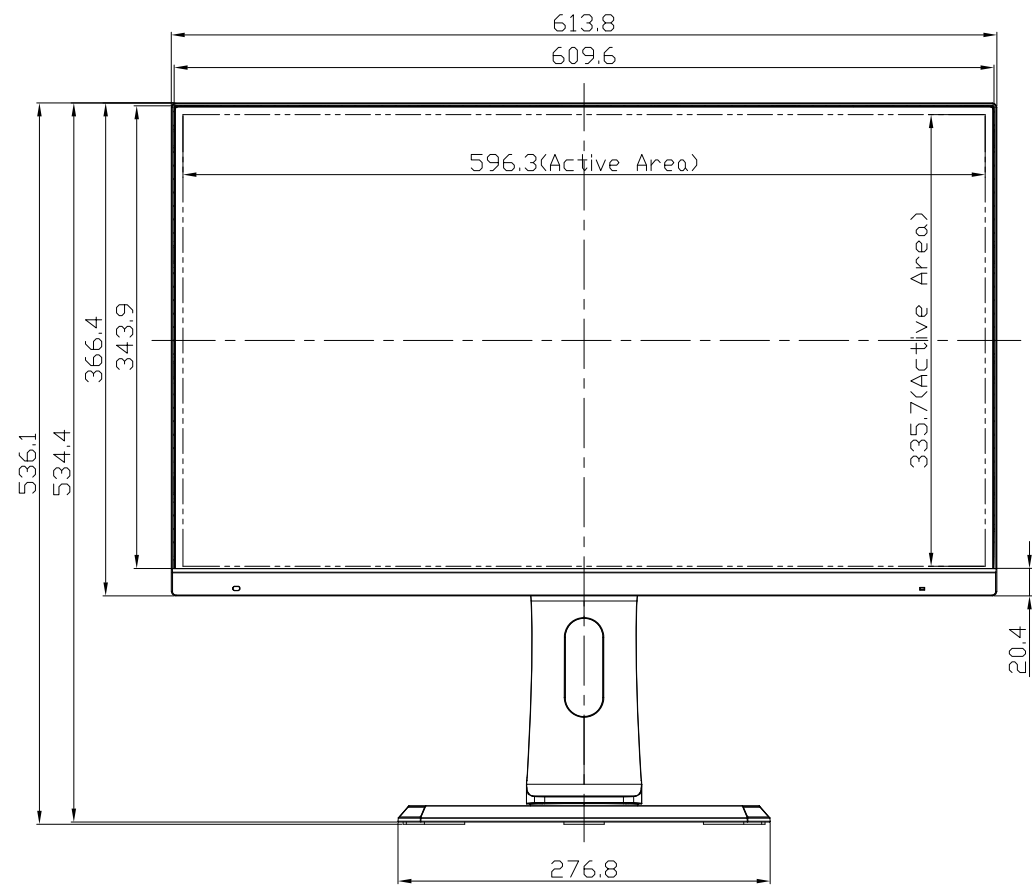
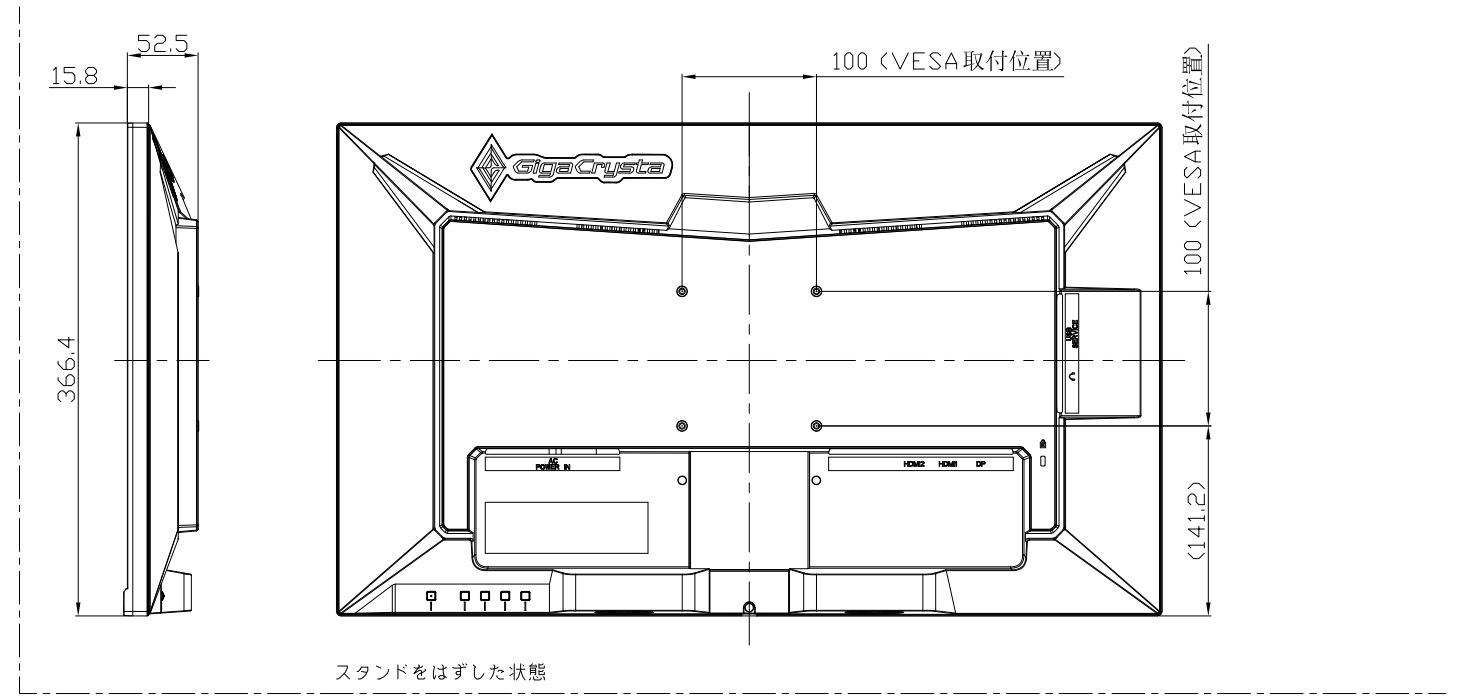
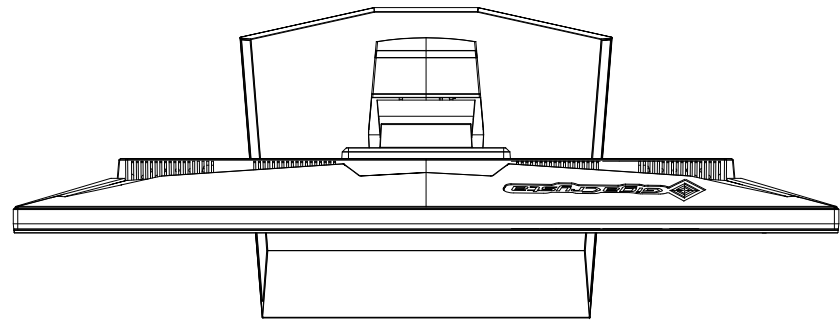

<注記>

- 1.)指示なき寸法公差は±2.0以下とする。
- 2.)中心線にActive Areaの中心を示す。
- 3.)指示なき寸法は中心線に対して対称とする。
- 4.)本図は参考資料に付予告無く変更する事がある。

GD271JD Series  
UNIT:mm

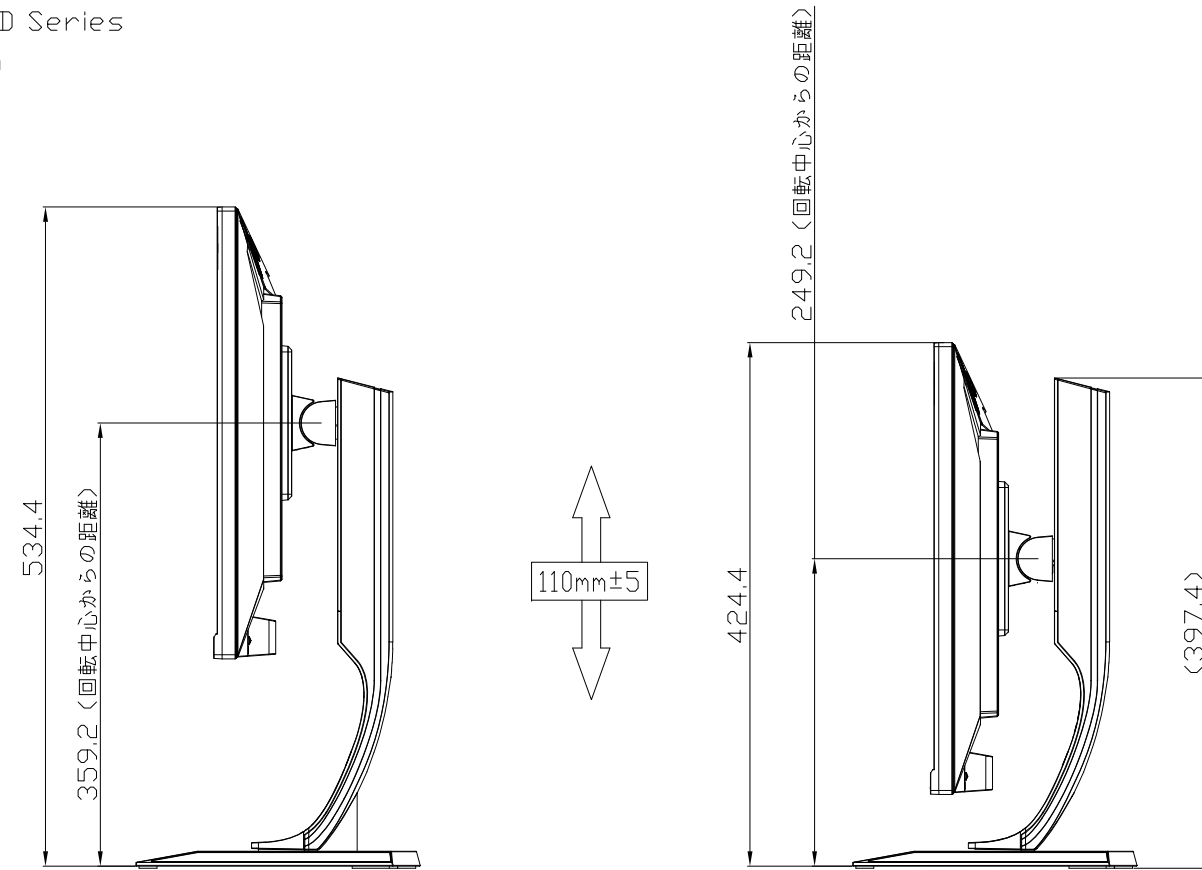

HEIGHT ADJUSTMENT VIEW

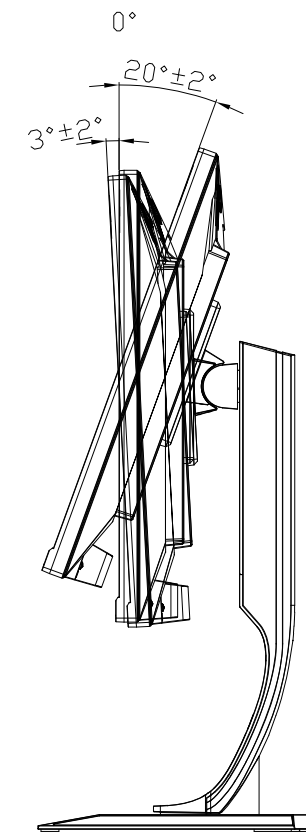

TILT VIEW

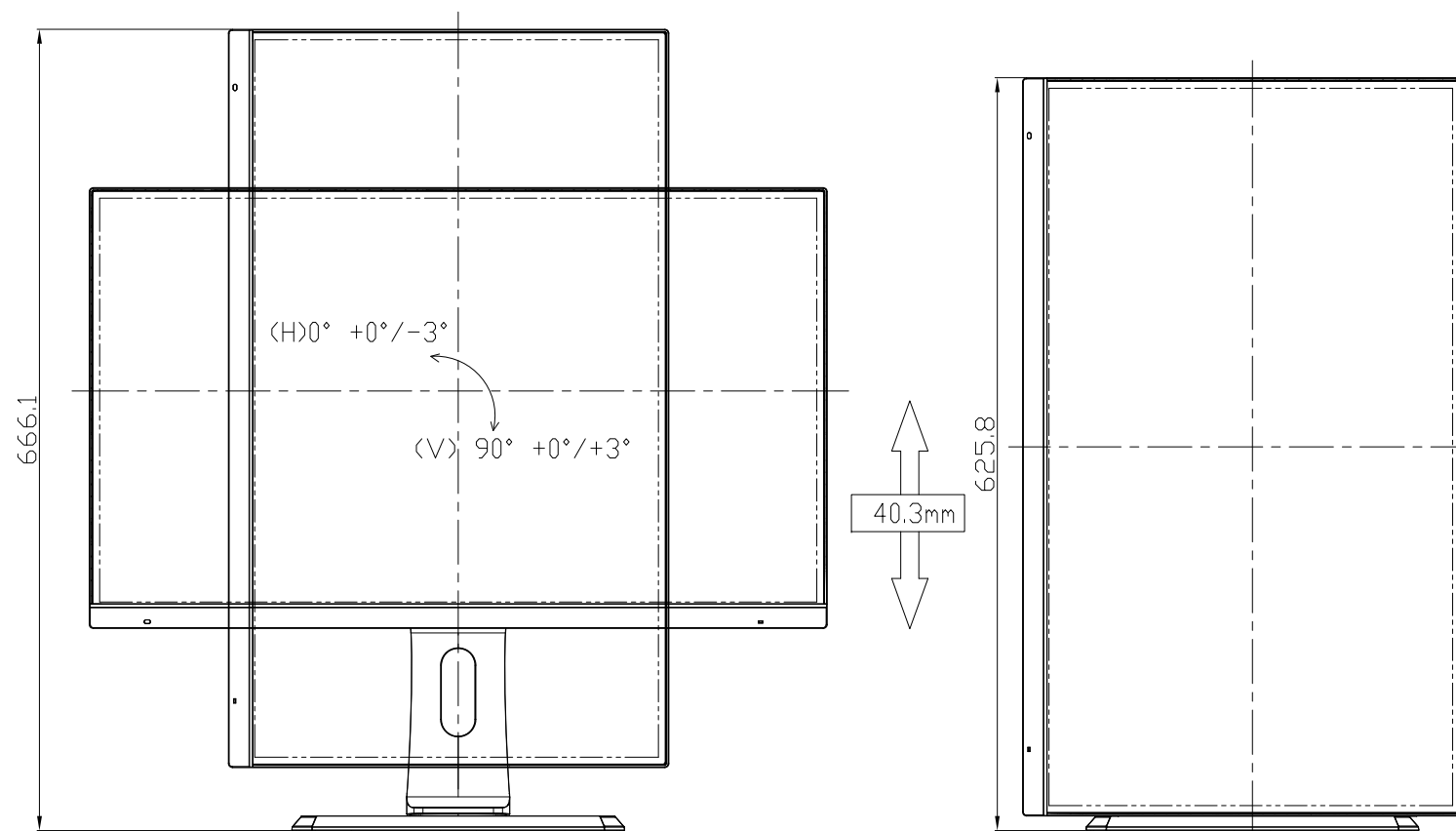

PIVOT VIEW

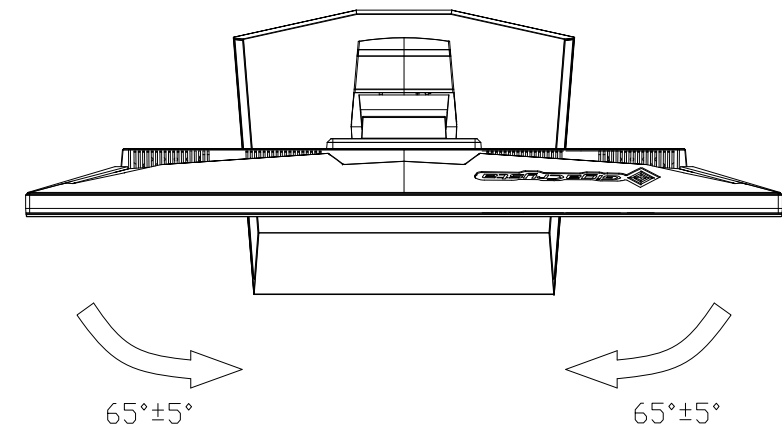

SWIVEL VIEW